



The Kernel Tempered Glass Coffee Table with Black and White Glossy Base

SKU: BC102



**FAB GLASS
AND MIRROR**

 www.fabglassandmirror.com  Call: +1 888-474-2221  Fax: (614)-334-4919

 Office Timing: 8:30 - 18:00 EST  info@fabglassandmirror.com

Thank you

Congratulations on the purchase of your new coffee table! We've made it very easy to install. Please read the following instructions carefully before you begin to install the coffee table. Using any other methods to install the Glass may lead to it breaking and will invalidate the warranty.

Glass Handling Cautions

Please read every step in the instructions before you begin installation. You are responsible for assembling, installing and taking care of your Glass according to the instructions. Users who fail to heed the instructions run the risk of injury, so please be careful and work with caution.

Hardware Included with this order

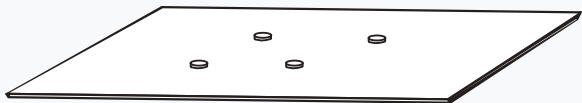

Glass Table Top
(Qty - 1)



Base
(Qty - 1)

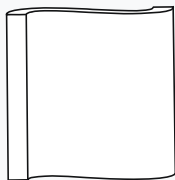

Curved Legs
(Qty - 2)

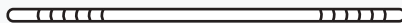

Rods
(Qty - 4)



Washers
(Qty - 4)



Nuts
(Qty - 4)



Tighten Key
(Qty - 1)

1

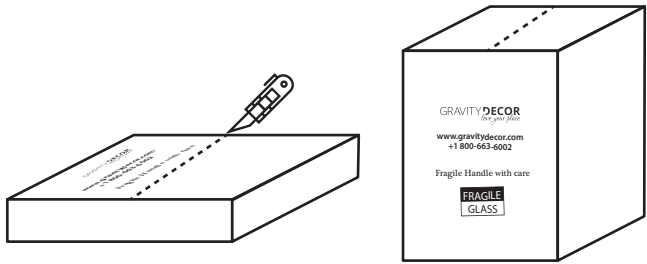

Open the table and accessories and remove from packaging, as per picture.

2

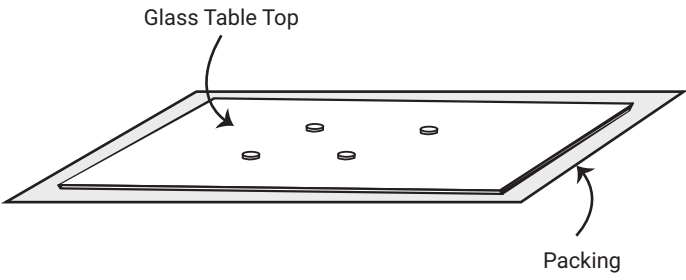

Place your glass table top upside down in a way that you can see its screw holes on top.

3

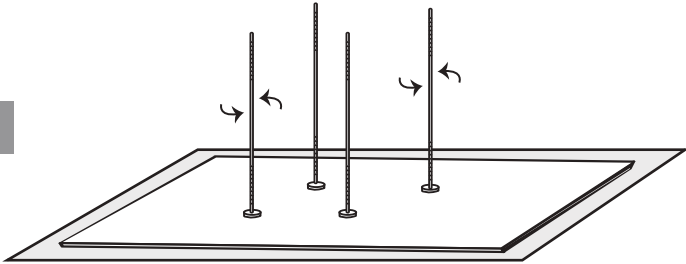

Next, tighten the rods manually.

4

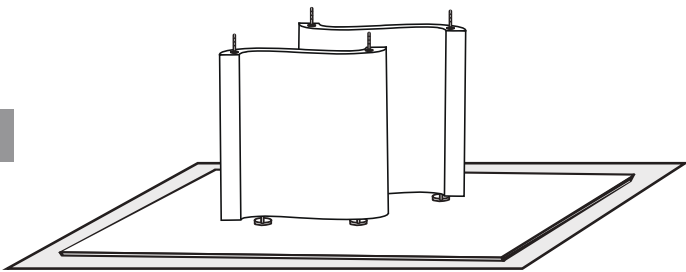

Insert the curved legs into the rods.

5

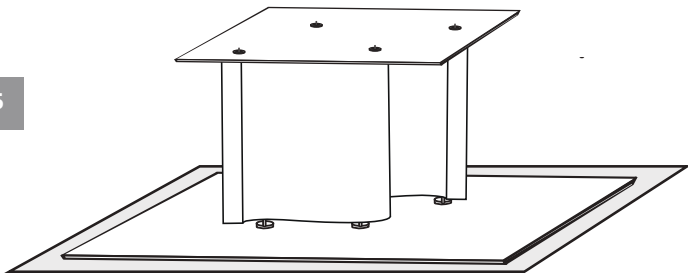

Fix the Table Base onto the legs.

6

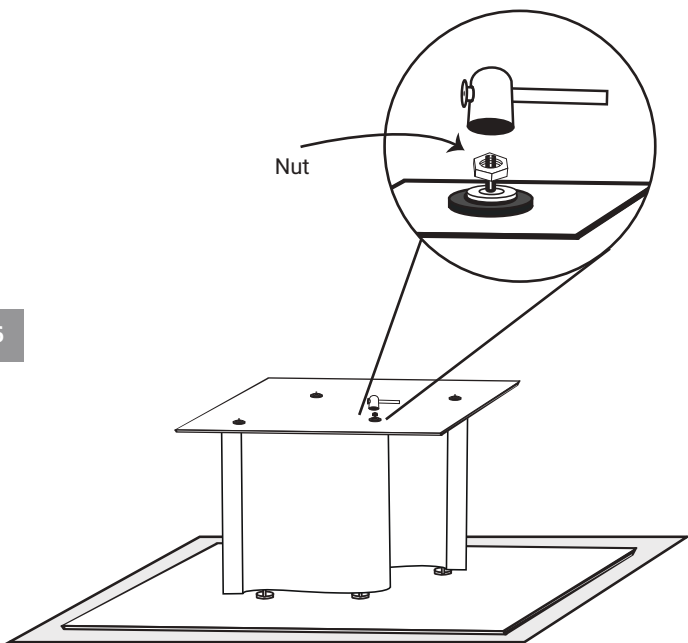

Tighten the washers and nuts on the rods by using the tightening key.

7

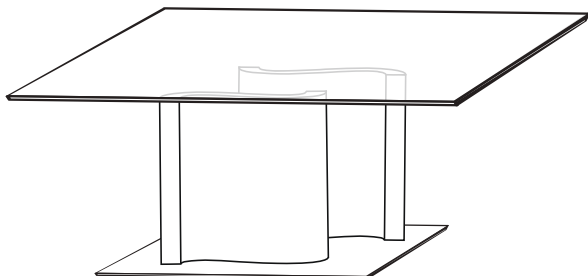

Turn your table around.

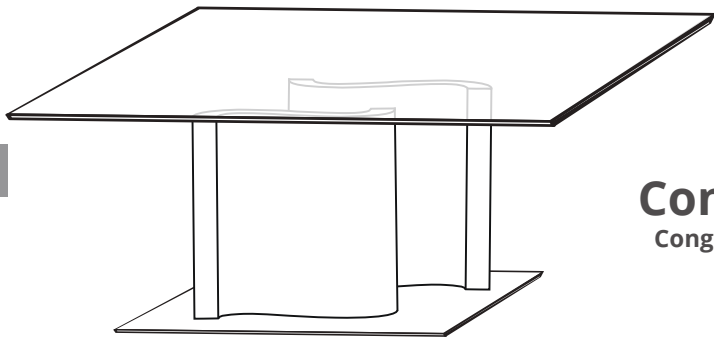

Congratulations!

Congratulations, your table is ready for use!