



# Glass Wall Cabinet Installation Manual

SKU: L-B145G1 / SKU: L-B145G2 / SKU: L-B145G3



**FAB GLASS  
AND MIRROR**

 [www.fabglassandmirror.com](http://www.fabglassandmirror.com)  Call: +1 888-474-2221  Fax: (614)-334-4919

 Office Timing: 8:30 - 18:00 EST  [info@fabglassandmirror.com](mailto:info@fabglassandmirror.com)

Congratulations on the purchase of your new Glass Cabinet! We've made it very easy to install. Follow all instructions carefully.



## CAUTION

Be Careful when using a knife or box cutter to open the packaging. Please read every step in the instructions before you begin installation. You are responsible for assembling, installing and taking care of your Glass Cabinet according to the instructions. Users who fail to heed the instruction run the risk of injury, so please be careful and work with caution.

## REQUIRED AND RECOMMENDED TOOLS

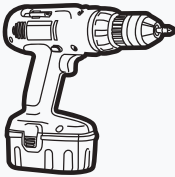

Drill/Driver

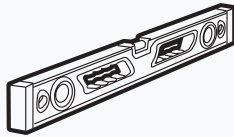

Level

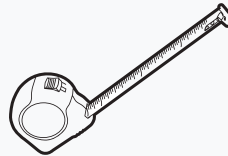

Tape Measure



Lead Pencil

## HARDWARE INCLUDED PER YOUR ORDER



Anchor  
(Qty - 2)



Screw  
(Qty - 2)

1



Remove the cabinet and accessories from the packaging, as per picture.

2

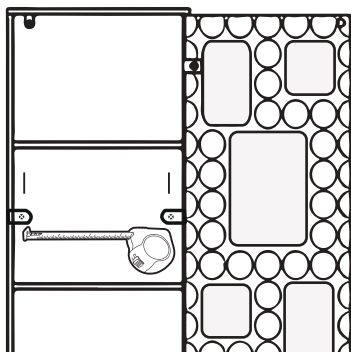

Measure distance between the two mounting holes on the back of the cabinet.

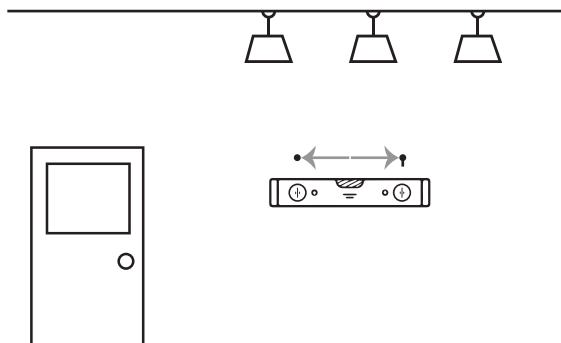

Using the measuring tape and LEAD pencil, mark the points on the wall where you will install the screws to hang the cabinet.

4

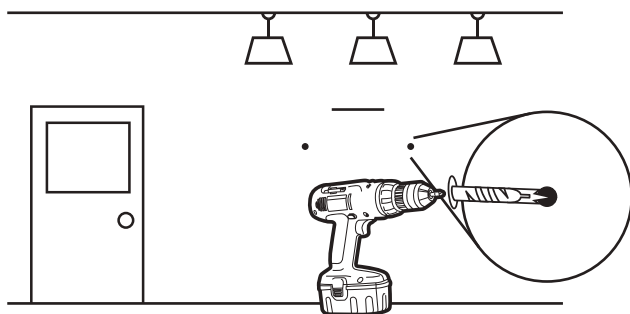

Drill the screws into the wall.

5

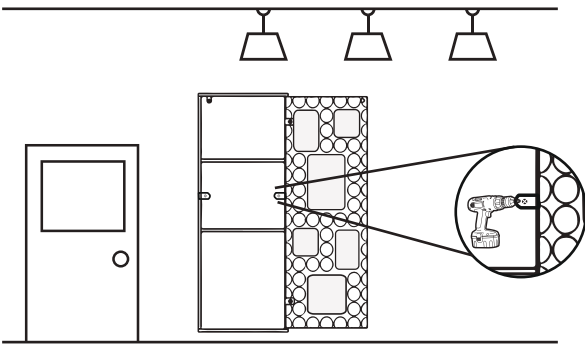

Tighten the screws from inside the cabinet rack area.

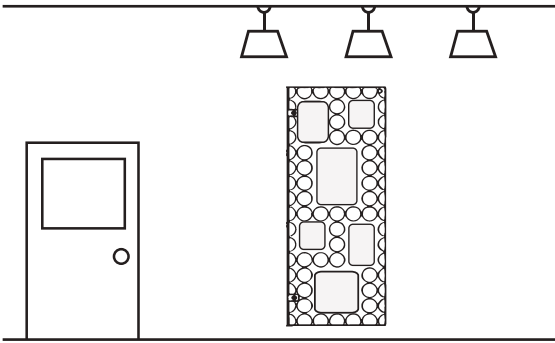

**Congratulations!**  
Your glass cabinet is ready for use!