



Round LED Wall Mirror Installation Manual

SKU: L-W04



**FAB GLASS
AND MIRROR**

 www.fabglassandmirror.com  Call: +1 888-474-2221  Fax: (614)-334-4919

 Office Timing: 8:30 - 18:00 EST  info@fabglassandmirror.com

Thank you for your purchase! It is our desire to make your entire experience from purchase to installation as easy as possible. We ask that you read each step of this installation manual thoroughly to ensure proper installation of your new LEDMirror. Our installation techniques are very important. Installing your Mirror in any manner other than the steps outlined in this manual may lead to structural failure of your Mirror.

Safety Backing Mirror:

A single sided woven tape is laminated onto the back of the mirror for security reasons if ever the glass is broken, the adhesive film holds the shattered pieces together, which significantly decreases the risk of injury.



CAUTION

It is your responsibility to see that your Mirror is properly assembled, installed, and cared for. Failure to follow instructions in this manual could result in serious injury. Use this product with Mirror cautions.

Tools Needed



Drill/Driver

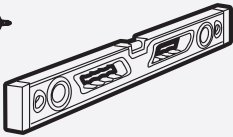

Level

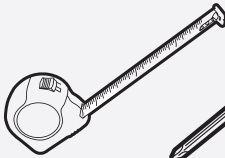

Tape Measure

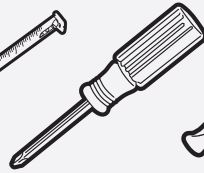

Screw Driver



Hammer



Lead Pencil

Hardware Included With This Order



Anchor
(Qty - 4/6)



Screw
(Qty - 4/6)

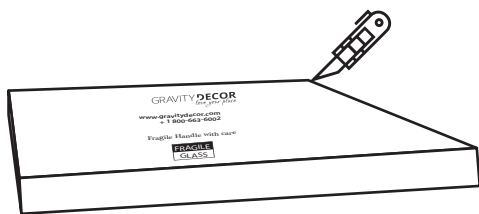

By using your cutting tool, carefully open the package and remove the mirror.

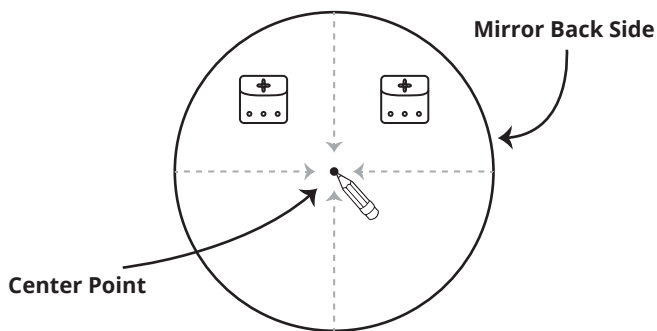

On the back side of the LED Mirror, use your pencil to mark the center point.

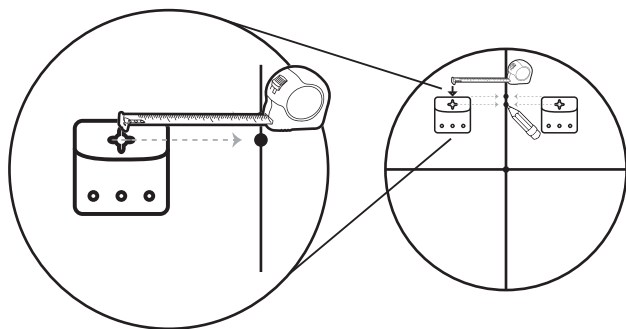

Measure the distance between the center point of the clips and write down the result.

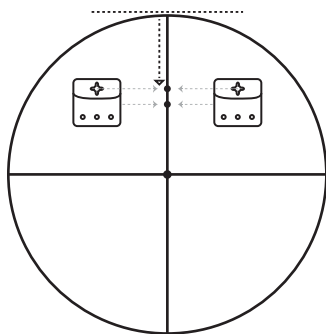

Measure the distance between the center point of the clips and write down the result.

5

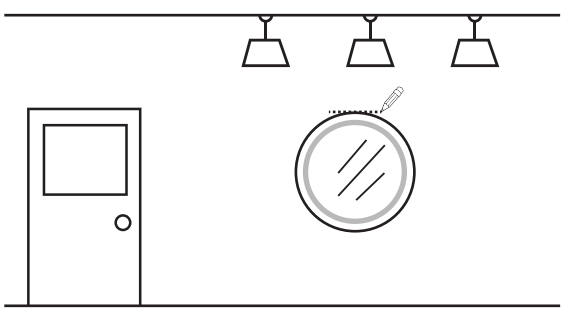

Hold the LED Mirror against the wall where you want to install it, and mark the wall at the top edge of the LED Mirror with the pencil.

6

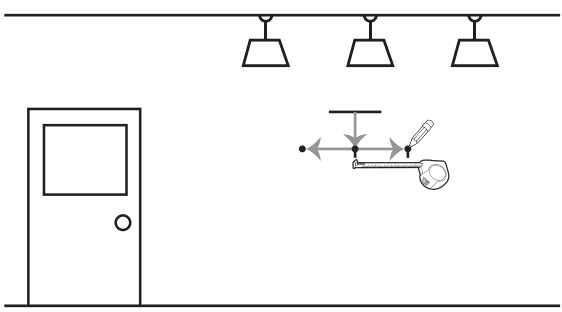

Using the results from the Steps 3 and 4, measure down from the top edge mark to the center point between the clips and place another mark, then from that mark measure out to the center of the clip body on each side and mark the wall in both spots.

7

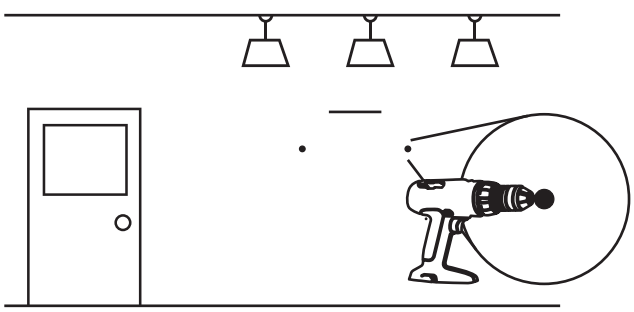

Drill two holes in the wall at the clip body center locations.

8

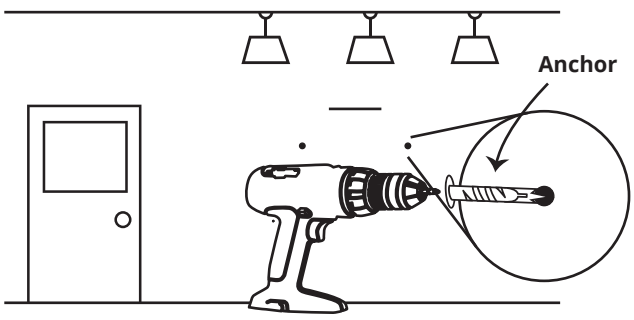

Using your drill, insert the anchor bolts in the holes.

9

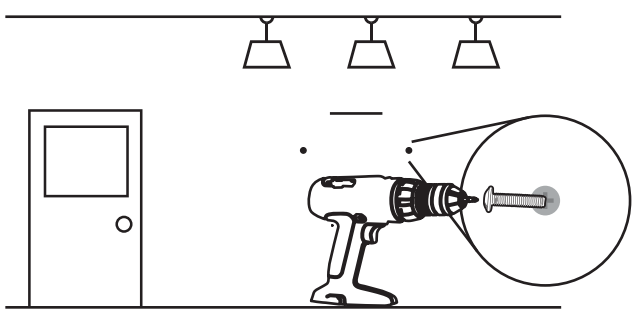

Now install the screw in the anchor with your drill.

10

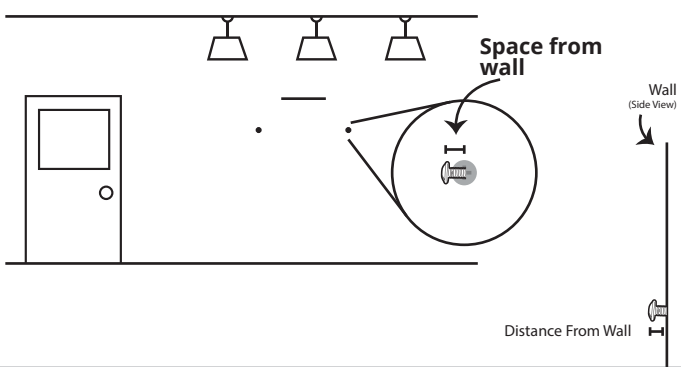

Leave 1/4" of space between the wall and the screw head.

11

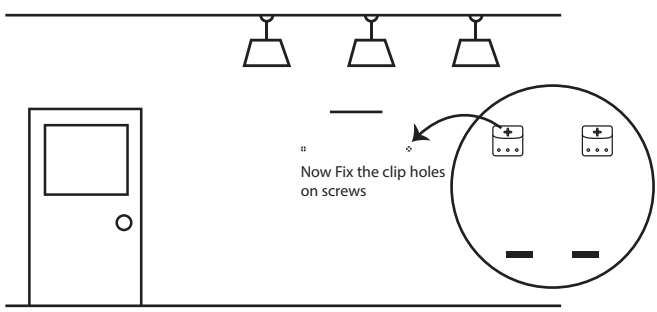

Hang the mirror on the wall by inserting the screw heads into the clips, and press gently against the bottom of the mirror to attach the sticky pads firmly to the wall.

12

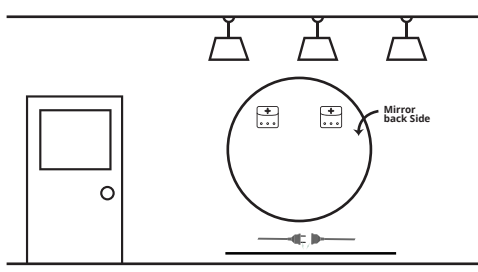

Connect the electric plug for LED lighting.

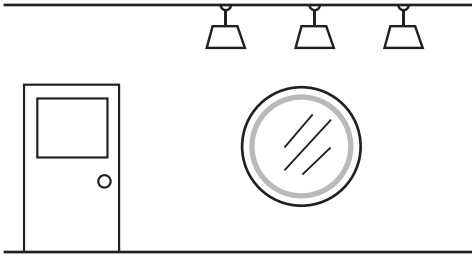

Congratulations!
You have successfully installed your
LED Wall Mirror. Enjoy!