

FAB GLASS AND MIRROR

www.fabglassandmirror.com







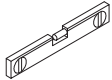

Assembly Instructions

Customer Service
US: +1 888-474-2221

Marcella Single Sliding Grid Shower Door

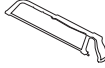

Tools Required

	
Spirit level	Tape measure
	
Power drill	Drill Bits
	
Silicone Gun	Screw driver
	
Pencil	Hacksaw
	
Rubber hammer	Safety glasses



CAUTION:

Risk of injury or product damage. During installation tempered glass should not come in direct contact with metal parts or it may shatter. Silicone must always be used between glass and metal. Do not touch the edges of tempered glass with tools. Do not attempt to cut tempered glass as it will shatter.

Please Carefully Read:

The installation instructions before installing. Check to make sure all of the accessories are in the package and you have the tools needed. It may be necessary to consult your tile supplier about the correct method for drilling tiles.

NOTE:

Tempered safety glass is stronger than normal glass but is not unbreakable. A scratch on the glass or contact with a hard surface (such as a screw head) can cause it to break. If it does break, it loudly explodes into thousands of small pieces

Please keep this manual and product code number for future reference and for ordering replacement parts if necessary.

GENERAL INSTRUCTIONS

- Read this manual carefully and completely before proceeding.
- It is recommended that you wear safety glasses at all times during the installation.

INSTALLATION OVER CERAMIC TILES

- If your shower door is to be installed over ceramic tiles, the tiles should lay completely under the wall jamb.
- Silicone should be used to seal the gap where the ceramic tiles meet the fixed panel.

NOTICE

- Caulking : no sealant is required inside the shower, unless otherwise stated.









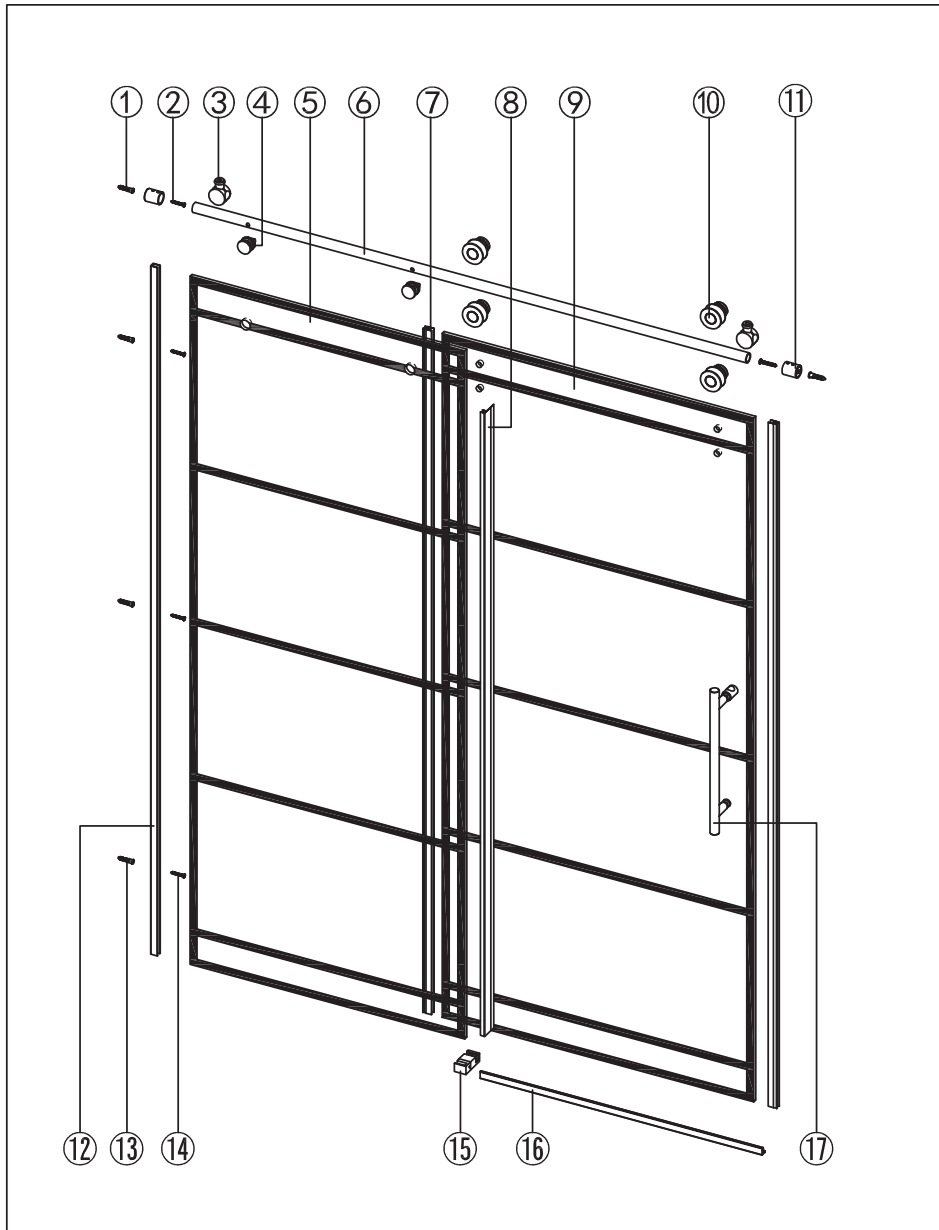







CARE FOR YOUR SHOWER DOOR

- Never use scouring powder pads or sharp instruments on metal pieces or glass panels.
- An occasional wiping down with a mild soap diluted in water is all that is needed to keep the panels and metal parts looking new
- We recommend wiping the glass panels with a squeegee after each use.

Product specifications are subject to change without notice

Detailed Diagram of Shower Enclosure Component



NO.	Name	Picture	Qty	NO.	Name	Picture	Qty
1	8mmWall plug		2	10	Roller		4
2	screw ST5x40		2	11	Guide rail bracket		2
3	Stopper		2	12	Wall profile		1
4	Glass fastener		2	13	6mmWall plug		3
5	Fixed panel		1	14	screw ST4x30		3
6	Guide Rail		1	15	Guide block		1
7	Door seal		2	16	Anti-splash threshold		1
8	Fixed panel seal		1	17	Towel bar		1
9	Sliding door		1	18			

1

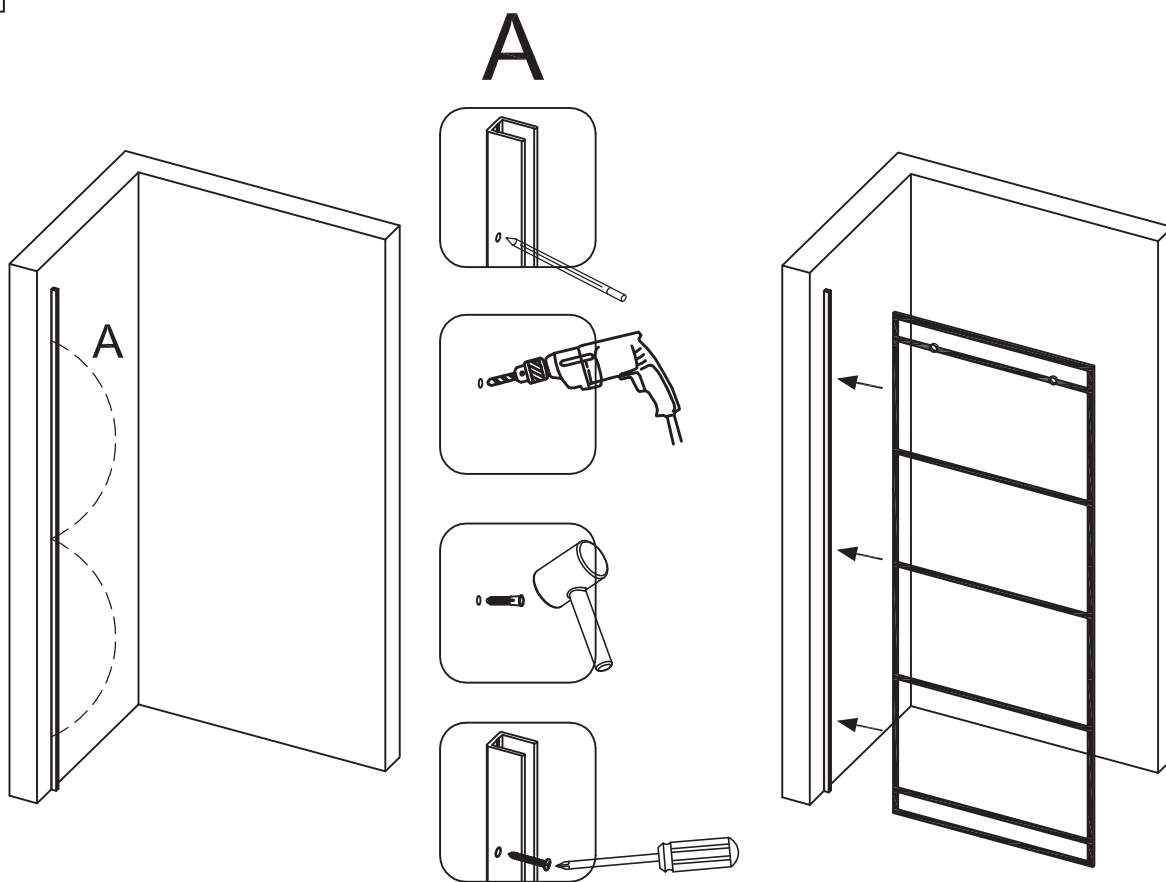

2

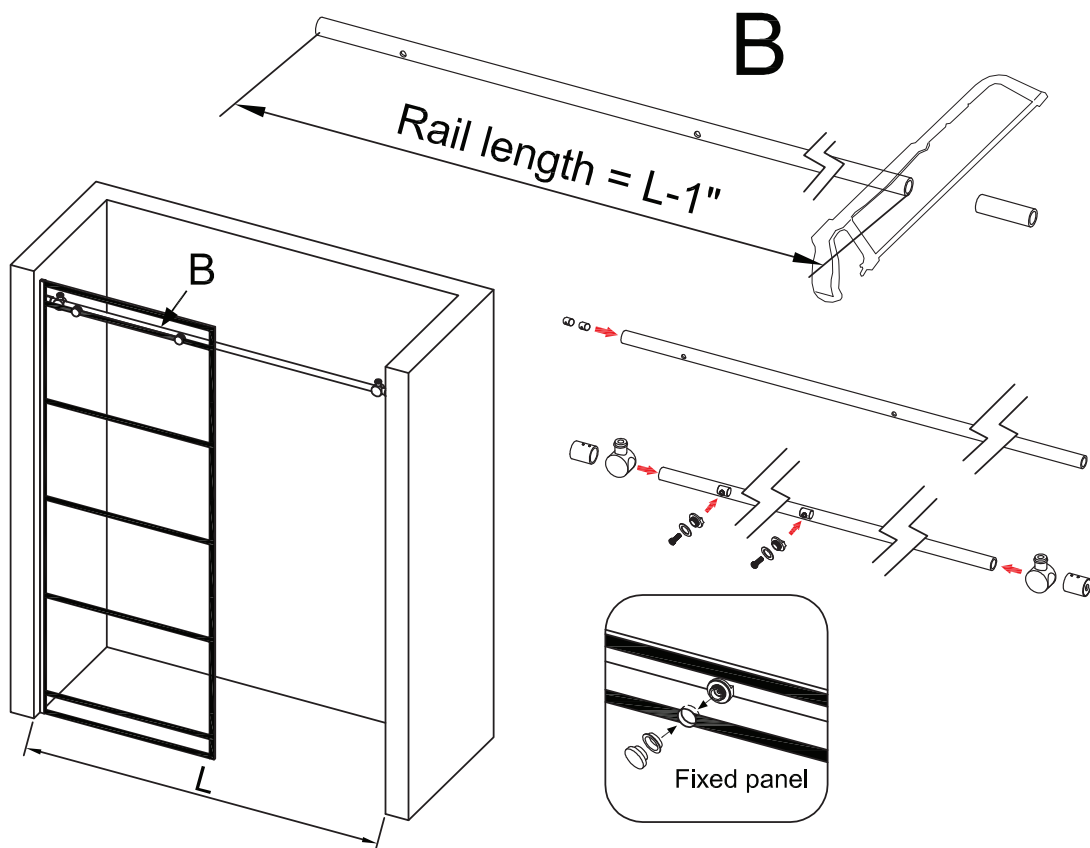

4

3

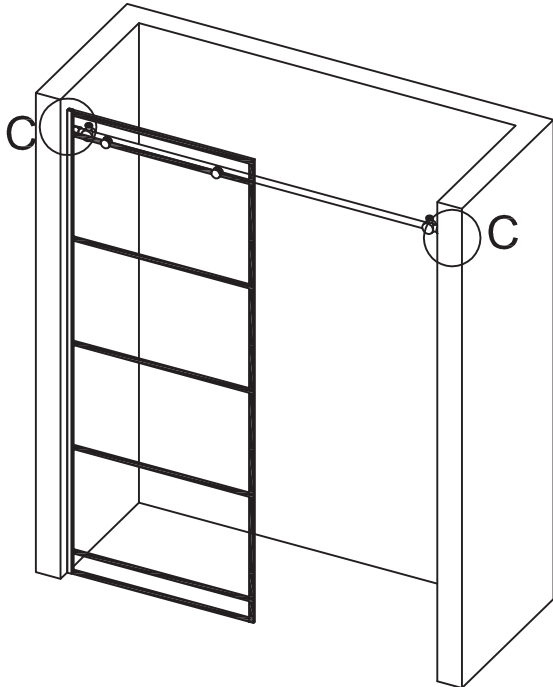

C

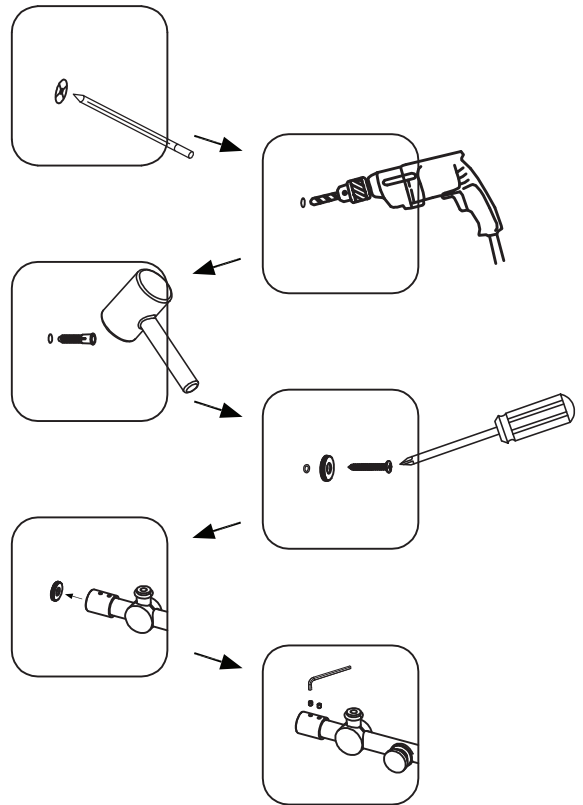

4

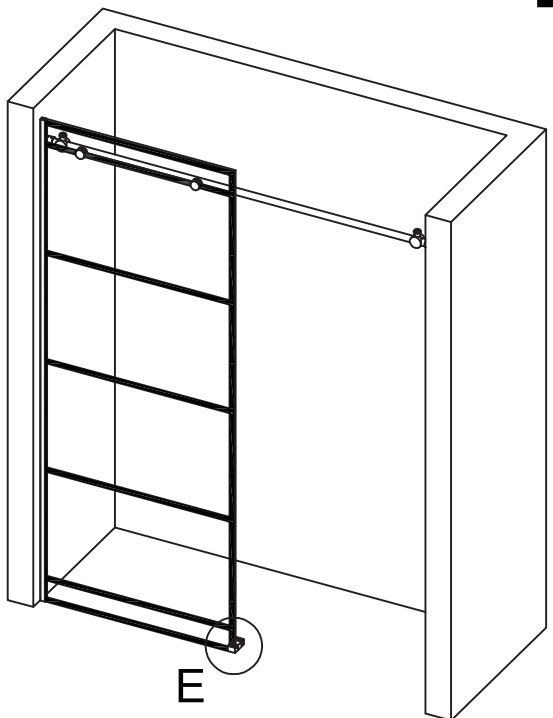

E

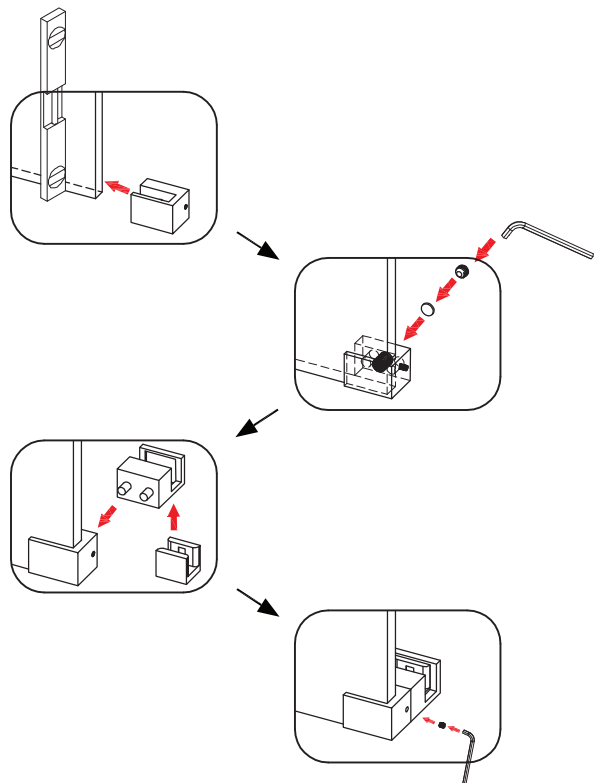

5

5

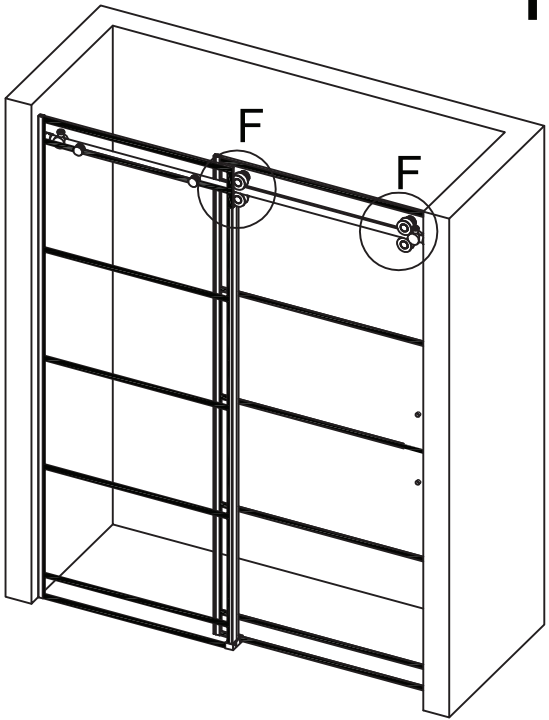

F

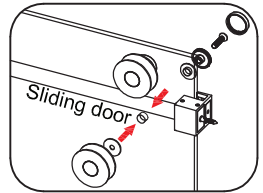
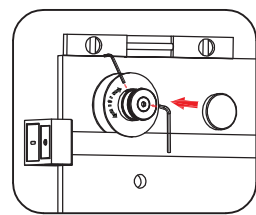
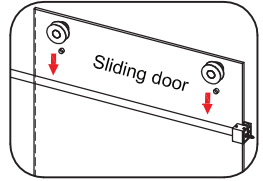
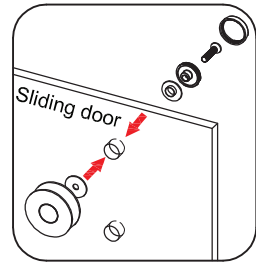

6

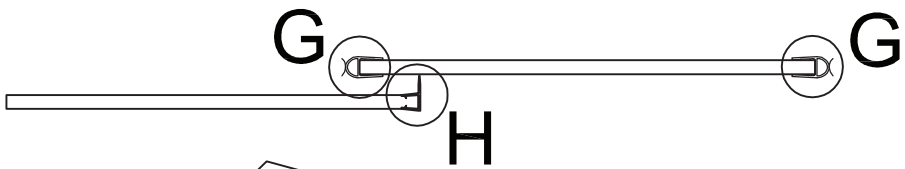

G

H

G

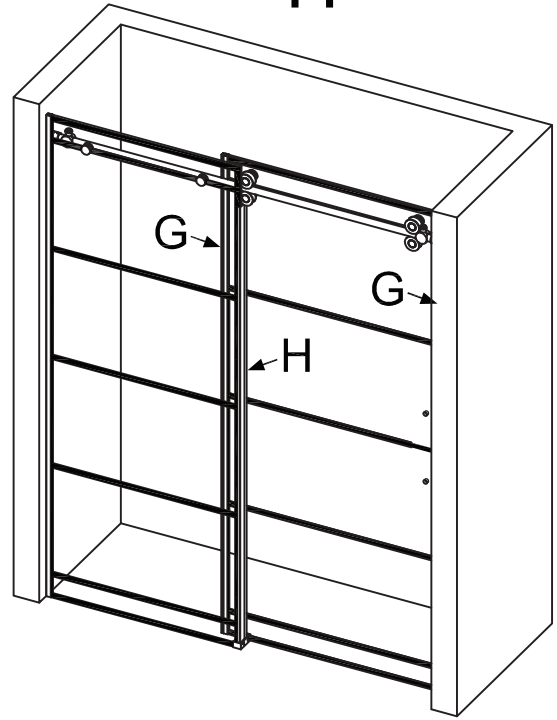

6

7

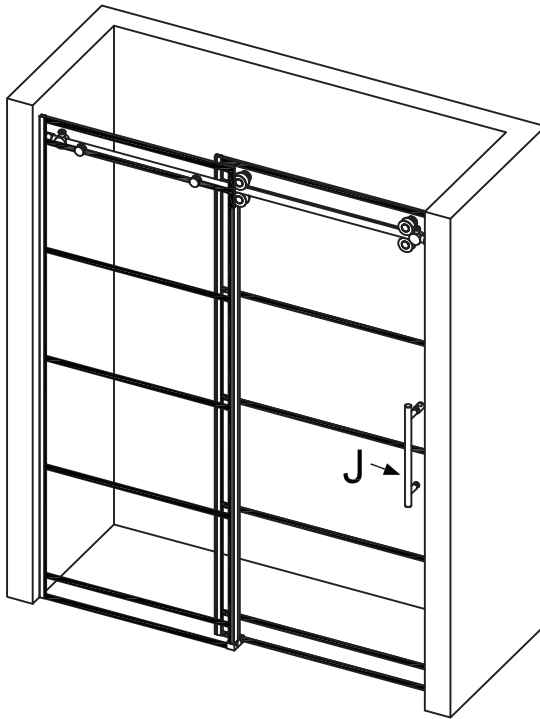

J

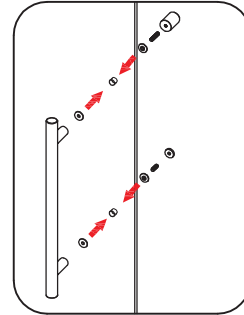

8

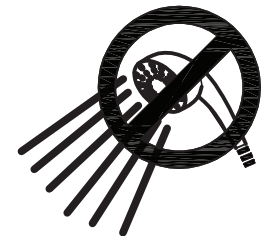
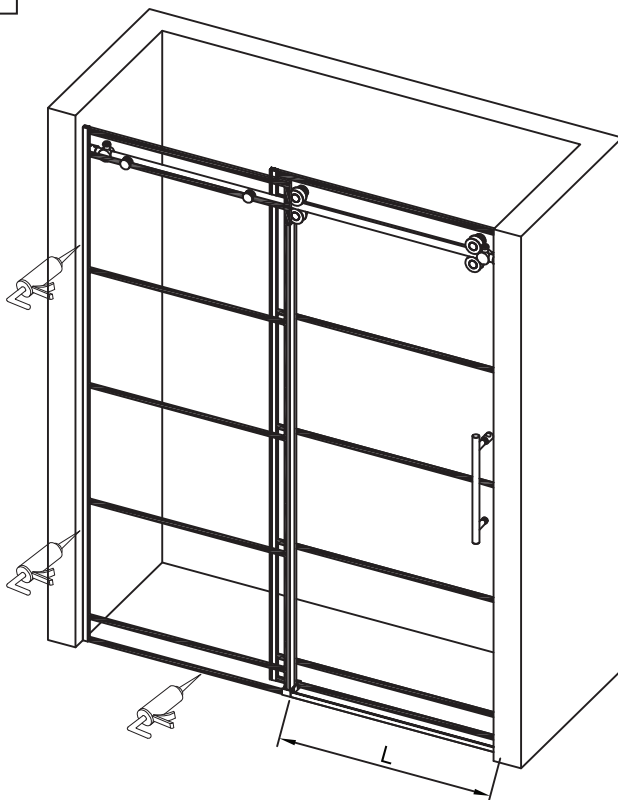

24 Hours

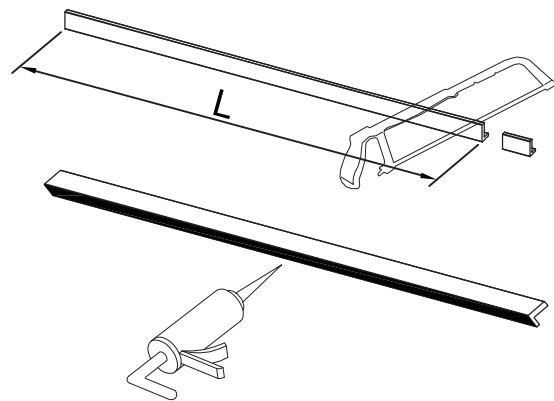

8